

PROFIBUS Network Adapter GN-9222

User Manual

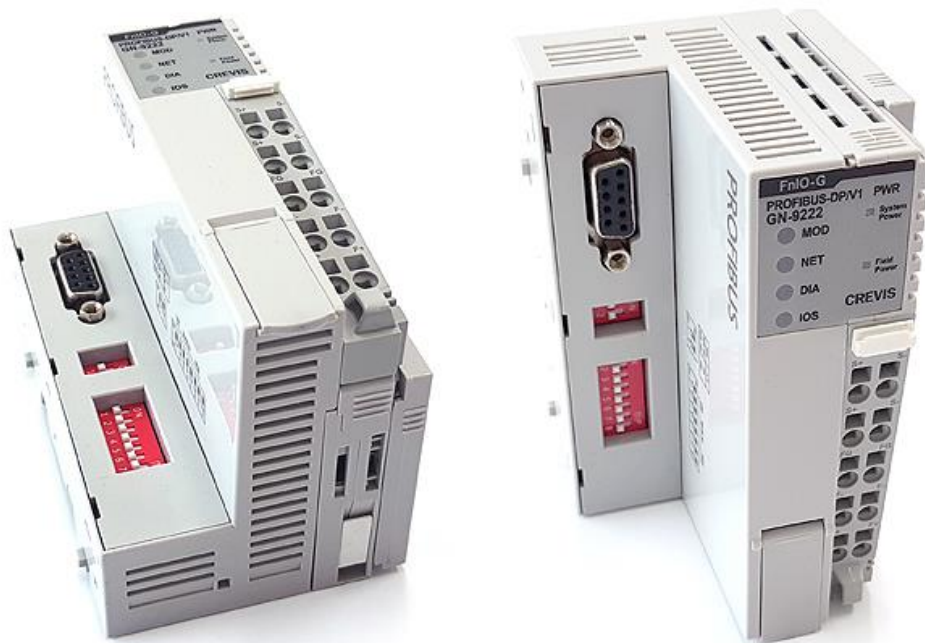

CREVIS co.,LTD

DOCUMENT CHANGE SUMMARY				
REV	PAGE	REMARKS	DATE	EDITOR
1.00	New Document		2018/07/30	JY HYUN
1.01	Add	Revision related to UL certification	2020/05/10	JY HYUN

CONTENTS

<u>1. Important Notes</u>	<u>5</u>
<u>1.1. Safety Instruction</u>	<u>5</u>
<u>1.1.1. Symbols.....</u>	<u>6</u>
<u>1.1.2. Safety Notes</u>	<u>6</u>
<u>1.1.3. Certification.....</u>	<u>6</u>
<u>2. Environment Specification</u>	<u>7</u>
<u>3. GN-9222(PROFIBUS Network Adapter)</u>	<u>8</u>
<u>3.1. GN-9222 Specification.....</u>	<u>8</u>
<u>3.2. GN-9222 Wiring Diagram</u>	<u>10</u>
<u>3.3. GN-9222 LED Indicator.....</u>	<u>11</u>
<u>3.3.1. LED Indicator</u>	<u>11</u>
<u>3.3.2. MOD(Module Status LED).....</u>	<u>11</u>
<u>3.3.3. NET(Network Status LED)</u>	<u>11</u>
<u>3.3.4. DIA(Diagnostic Status LED)</u>	<u>12</u>
<u>3.3.5. IOS LED(Expansion Module Status LED)</u>	<u>12</u>
<u>3.3.6. Field Power, System Power LED</u>	<u>12</u>
<u>3.4. GN-9222 Electrical Interface</u>	<u>13</u>
<u>3.4.1. PROFIBUS Connector.....</u>	<u>13</u>
<u>3.4.2. Dip Switch</u>	<u>13</u>
<u>3.4.3. RS232 Port for MODBUS/RTU, Touch Panel or IO Guide.....</u>	<u>14</u>
<u>3.5. I/O Process Image Map.....</u>	<u>14</u>
<u>3.5.1. Example of Input Process Image (Input Register) Map</u>	<u>15</u>
<u>3.5.2. Example of Output Process Image (Input Register) Map</u>	<u>16</u>
<u>4 Dimension</u>	<u>17</u>
<u>4.1. GN-9222</u>	<u>17</u>
<u>5. Mechanical Set Up</u>	<u>18</u>
<u>5.1. Total Expansion.....</u>	<u>18</u>
<u>5.2. Plugging and Removal of the Components.....</u>	<u>18</u>
<u>5.3. Internal G-Bus/Field Power Contacts.....</u>	<u>19</u>
<u>6. PROFIBUS Electrical Interface</u>	<u>20</u>
<u>6.1. G-Bus System.....</u>	<u>20</u>

6.2.PROFIBUS Electrical Interface	22
6.2.1. GN-9222	22
6.2.2. Terminator Resistor	23
6.2.3. PROFIBUS Address Setup	24
6.2.4. Choice of PROFIBUS data transfer cable type.....	25
6.2.5. I/O Process Image Map.....	26
7. Parameter	27
7.1. GN-9222	27
8. DPV1 Service.....	27
8.1. MSAC1 Read(PROFIBUS-DP Extensions to EN50170)	27
8.2. MSAC1 Write(PROFIBUS-DP Extensions to EN50170)	28
8.3. Error Decode(PROFIBUS-DP Extensions to EN50170).....	29
8.4. Error Decode 1(PROFIBUS-DP Extensions to EN50170)	29
8.5. Dignostics.....	30
9. MODBUS Interface	31
9.1. MODBUS Interface Register/Git Map	31
9.2. Supported MODBUS Function Codes.....	31
9.2.1. 8(0x08) Diagnostics	33
9.2.2. Error Response	34
9.3. MODBUS Special Register Map.....	35
9.3.1. Adapter Identification Special Register(0x1000,4096).....	35
9.3.2. Adapter Information Special Register(0x1100,4352)	36
9.3.3. Expansion Slot Information Special Resister(0x2000,8192)	36
10. Trouble Shooting	39
10.1. How to diagnose by LED indicator.....	39
A. APPENDIX A	41
A.1. Product List.....	41
A.2. Glossary	43

1. Important Notes

Solid state equipment has operational characteristics differing from those of electromechanical equipment. Safety Guidelines for the Application, Installation and Maintenance of Solid State Controls describes some important differences between solid state equipment and hard-wired electromechanical devices.

Because of this difference, and also because of the wide variety of uses for solid state equipment, all persons responsible for applying this equipment must satisfy themselves that each intended application of this equipment is acceptable.

In no event will CREVIS be responsible or liable for indirect or consequential damages resulting from the use or application of this equipment.

The examples and diagrams in this manual are included solely for illustrative purposes. Because of the many variables and requirements associated with any particular installation, CREVIS cannot assume responsibility or liability for actual use based on the examples and diagrams.



Warning!

- ✓ **If you don't follow the directions, it could cause a personal injury, damage to the equipment or explosion**
- Do not assemble the products and wire with power applied to the system. Else it may cause an electric arc, which can result into unexpected and potentially dangerous action by field devices. Arching is explosion risk in hazardous locations. Be sure that the area is non-hazardous or remove system power appropriately before assembling or wiring the modules.
- Do not touch any terminal blocks or IO modules when system is running. Else it may cause the unit to an electric shock or malfunction.
- Keep away from the strange metallic materials not related to the unit and wiring works should be controlled by the electric expert engineer. Else it may cause the unit to a fire, electric shock or malfunction.

Caution!

- ✓ **If you disobey the instructions, there may be possibility of personal injury, damage to equipment or explosion. Please follow below Instructions.**
- Check the rated voltage and terminal array before wiring. Avoid the circumstances over 55°C of temperature. Avoid placing it directly in the sunlight.
- Avoid the place under circumstances over 85% of humidity.
- Do not place Modules near by the inflammable material. Else it may cause a fire.
- Do not permit any vibration approaching it directly.
- Go through module specification carefully, ensure inputs, output connections are made with the specifications. Use standard cables for wiring.
- Use Product under pollution degree 2 environment.

1.1.1. Symbols

<p>DANGER</p> 	<p>Identifies information about practices or circumstances that can cause an explosion in a hazardous environment, which may lead to personal injury or death property damage or economic loss.</p>
<p>IMPORTANT</p>	<p>Identifies information that is critical for successful application and understanding of the product.</p>
<p>ATTENTION</p> 	<p>Identifies information about practices or circumstances that can lead to personal injury, property damage, or economic loss. Attentions help you to identify a hazard, avoid a hazard, and recognize the consequences.</p>

1.1.2. Safety Notes

<p>DANGER</p> 	<p>The modules are equipped with electronic components that may be destroyed by electrostatic discharge. When handling the modules, ensure that the environment (persons, workplace and packing) is well grounded. Avoid touching conductive components, e.g. G-BUS Pin.</p>
----------------------------------------------------------------------------------------------------------	------------------------------------------------------------------------------------------------------------------------------------------------------------------------------------------------------------------------------------------------------------------------------

1.1.3. Certification

c-UL-us UL Listed Industrial Control Equipment, certified for U.S. and Canada
See UL File E235505

FCC, Reach, RoHS- II, China RoHS

CE Certificate

EN 61000-6-2; Industrial Immunity
EN 61000-6-4; Industrial Emissions

2. Environment Specification

Environment Specification	
Operating Temperature	60°C ~ 70°C : Power dissipation is limited to 0.8A -40°C ~ 60°C : 1.5A full load is allowed
UL Temperature	-20°C ~ 60°C
Storage Temperature	-40°C ~ 85°C
Relative Humidity	5% ~ 90% non-condensing
Mounting	DIN rail
General Specification	
Shock Operating	IEC 60068-2-27
Vibration resistance	Based on IEC 60068-2-6 DNVGN-CCG-0039 : Vibration Class B, 4g
Industrial Emissions	EN 61000-6-4/ALL : 2011
Industrial Immunity	EN 61000-6-2 : 2005
Installation Position	Vertical and horizontal installation is available.
Product Certifications	CE, UL, FCC

3. GN-9222 (PROFIBUS Network Adapter)

3.1. GN-9222 Specification

Interface Specification, GN-9222	
Communication Interface Specification	
Redundancy	Not supported
Repeater Control Signal	RS-485 Signal
Freeze mode	Support
Sync mode	Support
Auto baudrate	Support
Fail safe mode	Support
Station type	Slave
FMS support	Not supported
Max. Network Node	125 Nodes
Max. Expansion Slot	63 Slots
I/O Data Size	Input : 244bytes / Output : 244bytes
Indicators	6 Status LEDs 1 Green/Red, Module Status (MOD) 1 Green/Red, Network Status (NET) 1 Red, Diagnostic Status (DIA) 1 Green/Red Expansion I/O Module Status (IOS) 1 Green, System Power Status 1 Green, Field Power Status
Communication Rate	9.6K~12M(1.2Km~100m)
Communication Speed	9.6 ~12000Kbps (Auto baudrate selection)
Bus Connection	9 Pin D-Sub Connector
Other Serial Port	RS232 for MODBUS/RTU, Touch Panel or IOGuide
Serial Configuration (RS232)	Node : 1 (Fixed) Baud Rate : 115200 (Fixed) Data bit : 8 (Fixed) Parity bit : No parity (Fixed) Stop bit : 1 (Fixed)
Module Location	Starter module left side of G-Series System
Field Power Detection	About 14Vdc
General Specification	
UL System Power	Supply voltage : 24Vdc Nominal, Class 2
System Power	Supply voltage : 24Vdc nominal Supply voltage range : 16~30Vdc Protection : Output current limit (Min. 1.5A) Reverse polarity protection
Power Dissipation	100mA @24Vdc
Current for I/O Module	1.5A @5Vdc

Isolation	System power to internal logic : Non-Isolation System power I/O driver : Isolation
UL Field Power	Supply voltage : 24Vdc nominal, Class 2
Field Power	Supply voltage : 24Vdc typical (Max.30Vdc) Field Power range is defferent depending on IO module series. Refer to IO module's specification.
Max. Current Field Power Contact	DC 10A Max.
Wiring	I/O Cable Max. 2.0mm ² (AWG 14)
Torque	0.8Nm(7 lb-in)
Weight	163g
Module Size	54mm x 99mm x 70mm
Environment Condition	Refer to 'Environment Specification'

* Operating temperature

-. -40 ~ 70 temperature range specification can be guaranteed°C under the follwing conditions.

-. Current for I/O Modules : 0.8A below.

-. Otherwise, temperature specification can be guranteed with -40 ~ 60°C.

3.2. GN-9222 Wiring Diagram

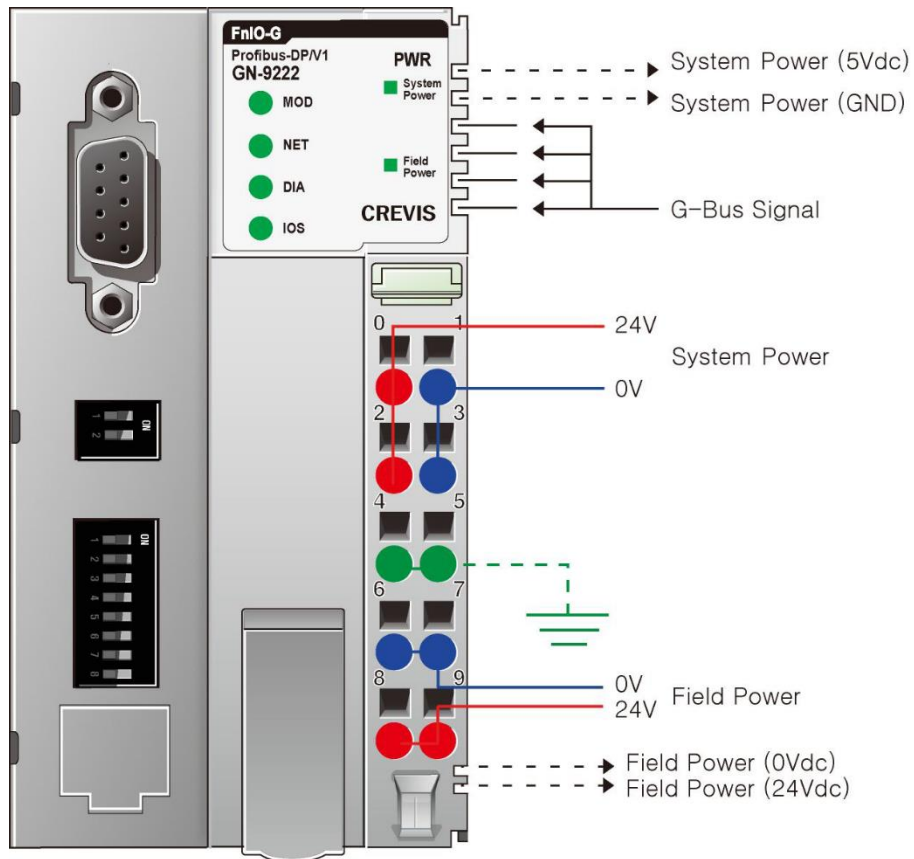

Pin No.	Signal Description	Signal Description	Pin No.
0	System Power, 24V	System Power, Ground	1
2	System Power, 24V	System Power, Ground	3
4	F.G	F.G	5
6	Field Power, Ground	Field Power, Ground	7
8	Field Power, 24V	Field Power, 24V	9

3.3. GN-9222 LED Indicator

3.3.1. LED Indicator

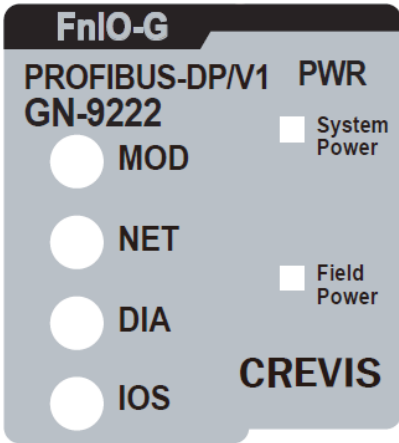

LED No.	LED Function / Description	LED Color
MOD	Module Status	Green/Red
NET	Network Status	Green/Red
DIA	Diagnostic Status	Red
IOS	Extension Module Status	Green/Red
System Power	System Power Enable	Green
Field Power	Field Power Enable	Green

3.3.2. MOD(Module Status LED)

Status	LED	To indicate
Not Powered	OFF	power is not supplied to the unit.
Normal, Operational	Green	The unit is operating in normal condition.
Device in Standby	Flashing Green	The EEPROM parameter is not initialized yet. Serial Number is zero value (0x00000000)
Minor Fault	Flashing Red	The unit has occurred recoverable fault in self-testing. - EEPROM checksum fault.
Unrecoverable Fault	Red	The unit has occurred unrecoverable fault in self-testing. - Firmware fault

3.3.3. NET(Network Status LED)

State	LED	To indicate
Not Powered Not On-line	OFF	Device is not on-line or may not be powered
On-line, Not connected	Flashing Green	Device is on-line but has no connections in the established state. - Not allocated to a master
On-line, Connected	Green	Device is on-line and allocated to a master
Connection Time-out	Flashing Red	One or more I/O connections are in the time-out state.
Critical Communication Failure	Red	Failed communication

3.3.4. DIA (Diagnostic Status LED)

Status	LED	To indicate :
Hardware Error	Flashing Red	Device has hardware cheching error. (with MOD led is red.)
Expansion Module Error	Flashing Red	Device has expansion module error. (with IOS led is red.)
IO Configuration Error	Flashing Red	Failed to initialize expansion module <ul style="list-style-type: none"> - Overflow Input/Output size. (244bytes / 244bytes) - Overflow Configuration data size. (244bytes / 244bytes) - Too many expansion module. (Max 63 slot) - Mismatch vendor code between adapter and expansion module.

3.3.5. IOS LED (Expansion Module Status LED)

State	LED	To indicate
Not Powered No Expansion Module	OFF	Device has no expansion module or may not be powered.
On-line, Do not Exchanging I/O	Flashing Green	I/O Communication is normal but does not exchanging I/O data. (Passed the expansion module confiration)
Connection, Run Exchanging I/O	Green	Exchanging I/O data.
Connection Fault during Exchanging I/O	Red	One or more expansion module occurred in fault state. <ul style="list-style-type: none"> - Changed expansion module configuration. - Communication failure.
Expansion Configuration Failed	Flashing Red	Failed to initialize expansion module. <ul style="list-style-type: none"> - Detect invalid expansion module ID. - Overflow Input/Outeput size. (244bytes/ 244bytes) - Too many expansion module. - Initial protocol failure. - Mismatch vendor code between adapter and expansion module.

3.3.6. Field Power, System Power LED (Field Power, System Power Status LED)

State	LED	To indicate
Not supplied field, system power	OFF	Not supplied 24Vdc field power, 5Vdc system poser.
Supplied field, system power	Green	Supplied 24Vdc field power, 5Vdc system power.

3.4. GN-9222 Electrical Interface

3.4.1. PROFIBUS Connector

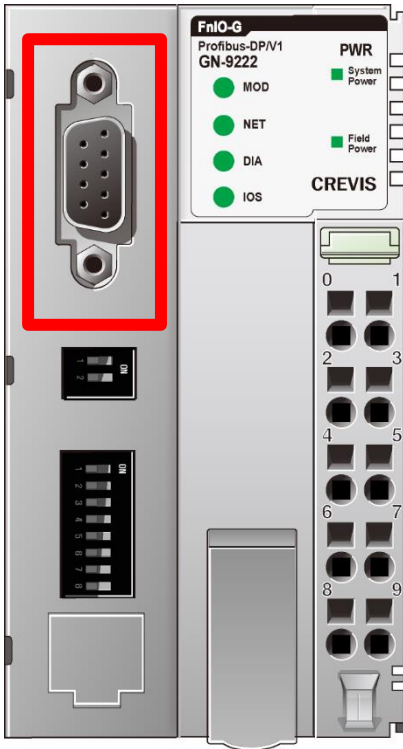

Pin No.	Description
3	RxD / TxD-P
4	CNTR-P
5	DGND
6	VP
8	RXD / TxD-N

3.4.2. Dip Switch



Terminating Resistance	1	2
Applied	On	On
Not applied	Off	Off

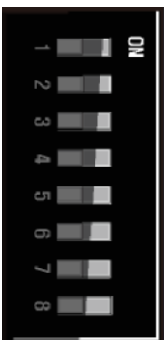

Node ID	1	2	3	4	5	6	7	8
1	On	Off	Off	Off	Off	Off	Off	Off
2	Off	On	Off	Off	Off	Off	Off	Off
~								
125	On	Off	On	On	On	On	On	Off

3.4.3. RS232 Port for MODBUS/RTU, Touch Panel or IOGuide

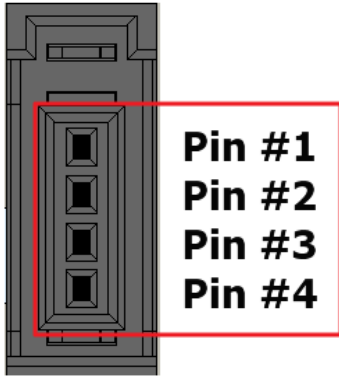

Pin#	Signal Name	Description
1	Reserved	----
2	TXD	RS232 TXD
3	RXD	RS232 RXD
4	GND	RS232 GND

3.5. I/O Process Image Map

An expansion module may have 3 types of data as I/O data, configuration parameter and memory register. The data exchange between network adapter and expansion modules is done via an I/O process image data by G-Series Internal Bus protocol. The following figure shows the data flow of process image between network adapter and expansion modules.

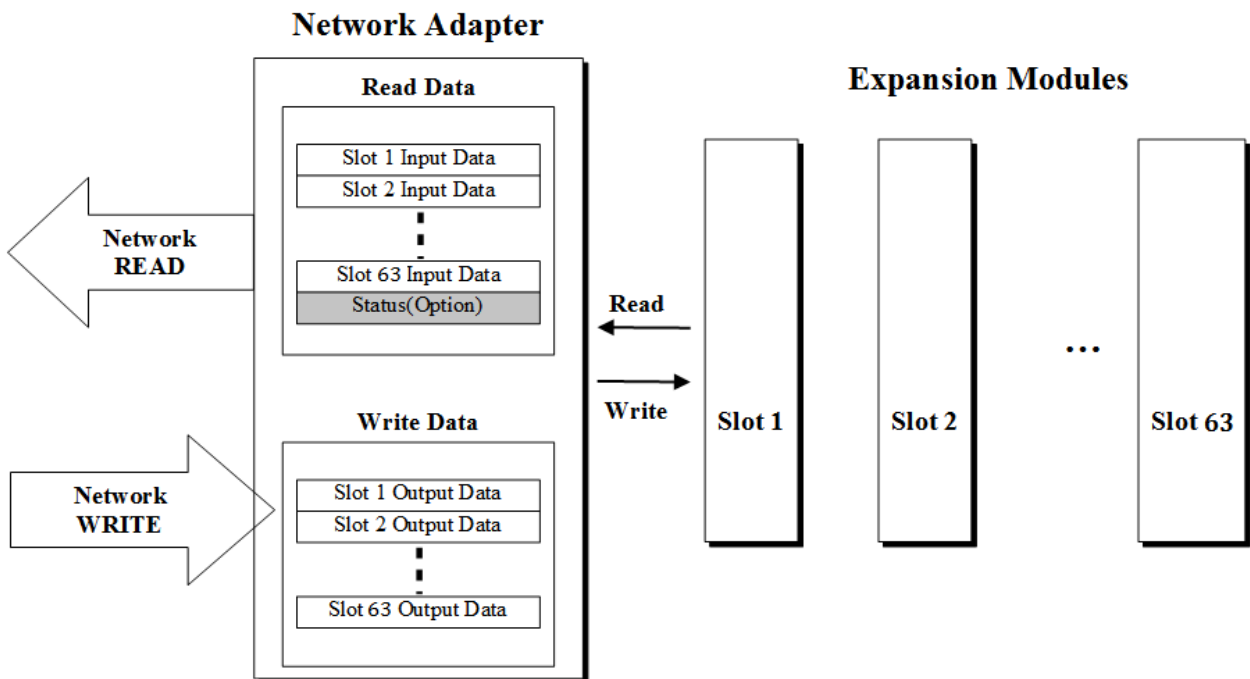

3.5.1. Example of Input Process Image (Input Register) Map

Input image data depends on slot position and expansion slot data type. Input process image data is only ordered by expansion slot position.

- For example slot configuration

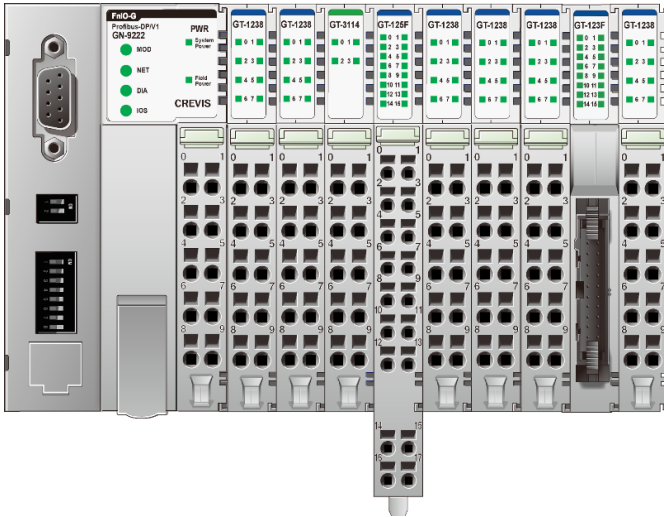

Slot Address	Module Description
#0	PROFIBUS Adapter
#1	8-discrete input
#2	8-discrete input
#3	4-analog input
#4	16-discrete input
#5	8-discrete input
#6	8-discrete input
#7	8-discrete input
#8	16-discrete input
#9	8-discrete input

- Input Process Image

Byte	Bit 7	Bit 6	Bit 5	Bit 4	Bit 3	Bit 2	Bit 1	Bit 0
0	Discrete Input 8 pts (Slot#1)							
1	Discrete Input 8 pts (Slot#2)							
2	Analog Input Ch0 low byte (Slot#3)							
3	Analog Input Ch0 high byte (Slot#3)							
4	Analog Input Ch1 low byte (Slot#3)							
5	Analog Input Ch1 high byte (Slot#3)							
6	Analog Input Ch2 low byte (Slot#3)							
7	Analog Input Ch2 high byte (Slot#3)							
8	Analog Input Ch3 low byte (Slot#3)							
9	Analog Input Ch3 high byte (Slot#3)							
10	Discrete Input 8 pts (Slot#4)							
11	Discrete Input 8 pts (Slot#4)							
12	Discrete Input 8 pts (Slot#5)							
13	Discrete Input 8 pts (Slot#6)							
14	Discrete Input 8 pts (Slot#7)							
15	Discrete Input 8 pts (Slot#8)							
16	Discrete Input 8 pts (Slot#8)							
17	Discrete Input 8 pts (Slot#9)							

3.5.2. Example of Output Process Image (Output Register) Map

Output image data depends on slot position and expansion slot data type. Output process image data is only ordered by expansion slot position.

• For example slot configuration

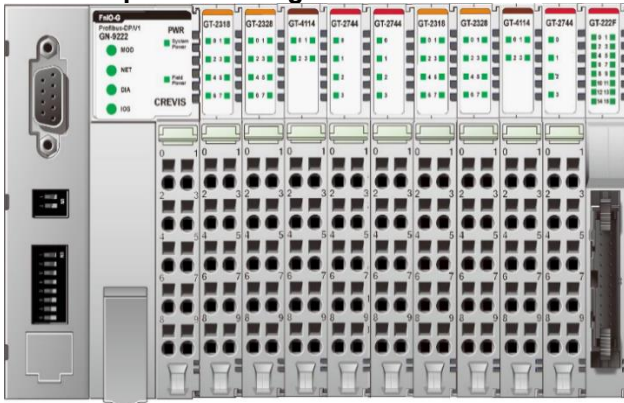

Slot Address	Module Description
#0	PROFIBUS Adapter
#1	8-discrete output
#2	8-discrete output
#3	4-analog output
#4	4-relay output
#5	4-relay output
#6	8-discrete output
#7	8-discrete output
#8	4-analog output
#9	4-relay output
#10	16-discrete output

Output Process Image Mode#0 (Uncompressed Input Processing Data), default output image

Byte	Bit 7	Bit 6	Bit 5	Bit 4	Bit 3	Bit 2	Bit 1	Bit 0
0	Discrete Output 8 pts(Slot#1)							
1	Discrete Output 8 pts(Slot#2)							
2	Analog Output Ch0 low byte(Slot#3)							
3	Analog Output Ch0 high byte(Slot#3)							
4	Analog Output Ch1 low byte(Slot#3)							
5	Analog Output Ch1 high byte(Slot#3)							
6	Analog Output Ch2 low byte(Slot#3)							
7	Analog Output Ch2 high byte(Slot#3)							
8	Analog Output Ch3 low byte(Slot#3)							
9	Analog Output Ch3 high byte(Slot#3)							
10	Discrete Output low 4 pts(Slot#4)							
12	Discrete Output low 4 pts(Slot#5)							
13	Discrete Output low 8 pts(Slot#6)							
14	Discrete Output low 8 pts(Slot#7)							
15	Analog Output Ch0 low byte(Slot#8)							
16	Analog Output Ch0 high byte(Slot#8)							
17	Analog Output Ch1 low byte(Slot#8)							
18	Analog Output Ch1 high byte(Slot#8)							
19	Analog Output Ch2 low byte(Slot#8)							
20	Analog Output Ch2 high byte(Slot#8)							
21	Analog Output Ch3 low byte(Slot#8)							
22	Analog Output Ch3 high byte(Slot#8)							
24	Discrete output low 8 pts(Slot#9)							
25	Discrete output low 8 pts(Slot#10)							
26	Discrete output low 8 pts(Slot#10)							

4. Dimension

4.1. GN-9222

(mm)

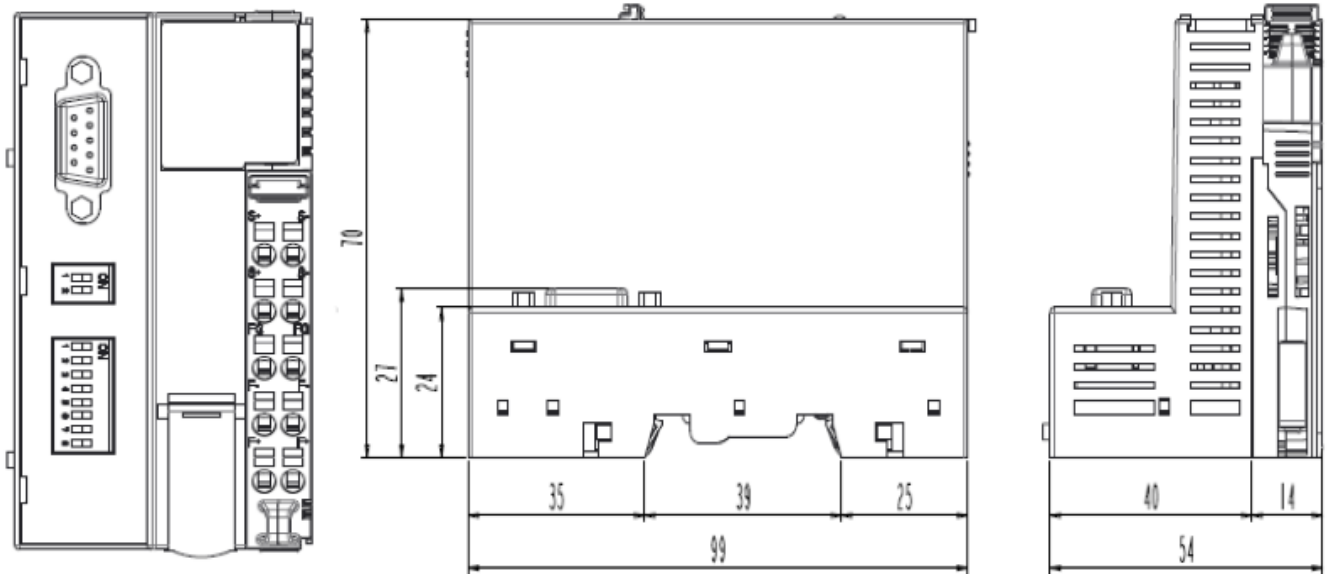

5. Mechanical Set Up

5.1. Total Expansion

The number of the module assembly that can be connected is 63. So the maximum length is 426mm
Exception.

5.2. Plugging and Removal of the Components.

<p>DANGER</p> 	<p>Before work is done on the components, the voltage supply must be turned off.</p>
--------------------------------------------------------------------------------------------------------	--------------------------------------------------------------------------------------



As above figure in order to safeguard the FnIO module from jamming, it should be fixed onto the DIN rail with locking level. To do so, fold on the upper of the locking lever.

To pull out the FnIO module, unfold the locking lever as below figure.



5.3. Internal G-Bus/Field Power Contacts

Communication between the NA series and the expansion module as well as system / field power supply of the bus modules is carried out via the internal bus. It is comprised of 6 data pin and 2 field power pin.

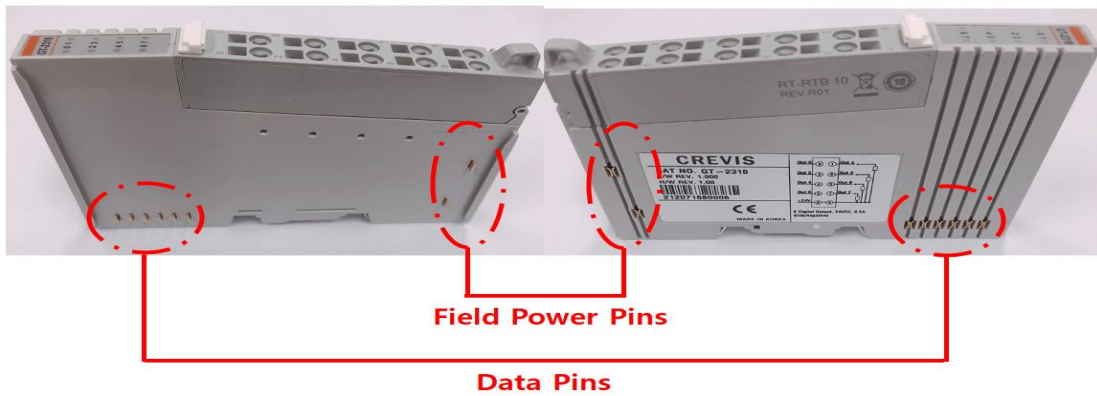

<p>DANGER</p> 	<p>Do not touch data and field power pins in order to avoid soiling and damage by ESD noise.</p>
----------------------------------------------------------------------------------------------------------	--------------------------------------------------------------------------------------------------

6.PROFIBUS Electrical Interface

6.1. G-Bus System

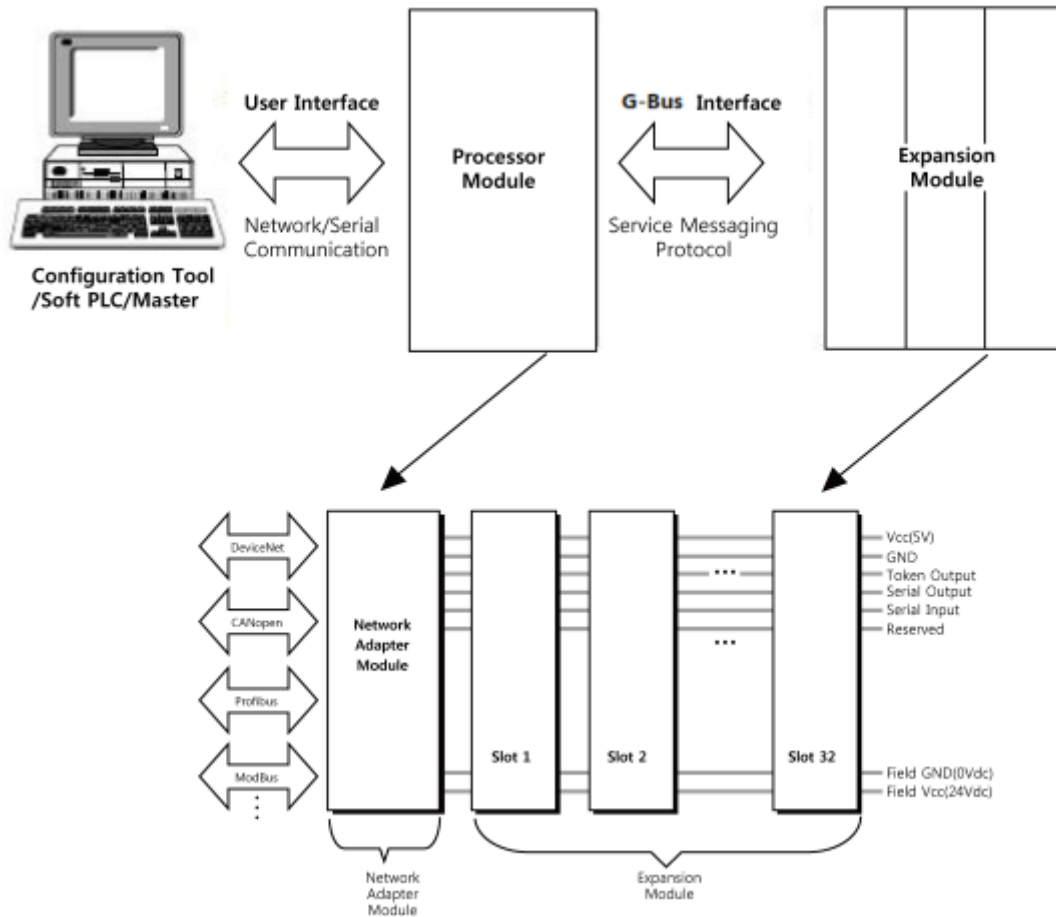

• Network Adapter Module

The Network Adapter Module forms the link between the field bus and the field devices with the Expansion Modules.

The connection to different field bus systems can be established by each of the corresponding Network Adapter Module, e.g. for SyncNet, PROFIBUS, CANopen, DeviceNet, Ethernet/IP, CC-Link, MODBUS/Serial, MODBUS/TCP etc.

• Expansion Module

The Expansion Modules are supported a variety of input and output field devices. There are digital and analog input/output modules and special function modules.

- **Two types of FnBus Message**

- Service Messaging
- I/O Messaging

FnBus Pin Description

No.	Name	Description
1	Vcc	System supply voltage (5V dc).
2	GND	System Ground.
3	Token Output	Token output port of Processor module.
4	Serial Output	Transmitter output port of Processor module.
5	Serial Input	Receiver input port of Processor module.
6	Reserved	Reserved for bypass Token.
7	Field GND	Field Ground.
8	Field Vcc	Field supply voltage (24Vdc).

6.2. PROFIBUS Electrical Interface

6.2.1. GN-9222

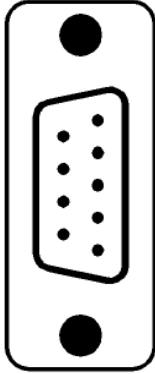

Dsub 9 (Female)	Signal Name	Description
1	-	
2		
3	RXD/TXD-P	Receive/Transmit data-plus(B wire)
4	CNTR-P	Repeater control signal(direction control), RTS signal
5	DGND	Data ground(reference potential for VP)
6	VP	Supply voltage-Plus(P5V)
7	-	
8	RXD/TXD-N	Receive/Transmit data-minus(A-wire)
9	CNTR-N	Repeater Control Signal(direction control)

All FieldBus devices which use a standard 9-pin Sub-D connector should provide the VP and DGND signals on the bus connector in addition to the receive and transmit signals. With all other connector types, only the receive and transmit signals need to be connected.

Make sure that the connector type used is suitable for the selected baud rate.

If optional signal are provided, they must also comply with EN50170 Volume 2 and they must be correctly described in the respective GSD file.

To prevent EMC interface from entering the device, the cable shield should be connected to the functional ground of the device (generally the electrically conductive case). This is done by connecting the cable shield to the metal case of the Sub-D connector and the functional ground over a larger area. The bus connector must have a low-impedance connection to the cable shield.

The data transfer technology of the serial bus system, which uses a shielded twisted pair data cable, is described in the specification of the interface-immune RS 485 interface standard. To allow correct bus termination, each station must connect the signals DGND and VP (5V) to pins 5 and 6 of the connector, respectively. The 5V supply for the terminating resistors (VP) should have a minimum current rating of 10mA (the current load can increase to 12mA if

a NULL signal is sent through the bus). The current rating should be increased to app.

90mA if you need to be able to supply other types of devices on the bus such as bus terminals and optical fiber cable drivers. Due to the capacitive load of the station and the resulting cable reflections, bus connectors should be provided with built-in series inductors as shown below.

ATTENTION



The use of an incorrect supply voltage or frequency can cause severe damage to the component..

6.2.2. Terminator Resistor

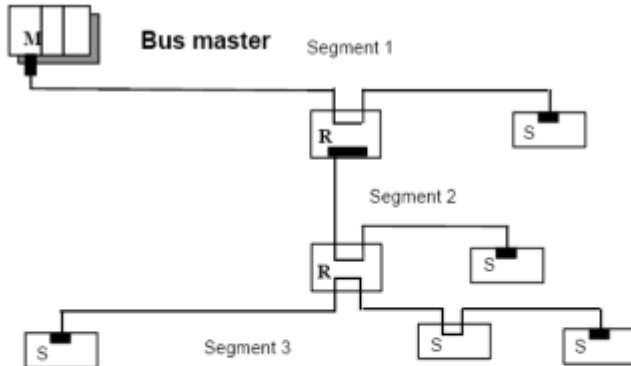

Legende:

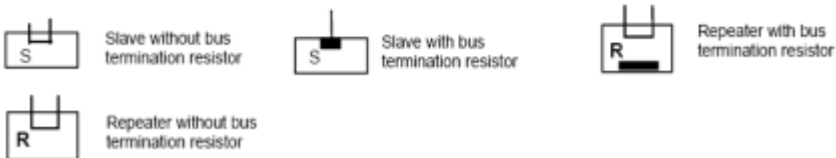

In order to minimize cable reflections and ensure a defined noise level on the data lines, the data transfer cable must be terminated at both ends with a terminating resistor combination as follows.

6.2.3. PROFIBUS Address Setup

Each PROFIBUS Adapter could have a unique address (from 1 to 99) so that it can be addressed independently from other nodes. The address 0 is reserved to identify a broadcast exchange. No response is returned to broadcast requests sent by the master.

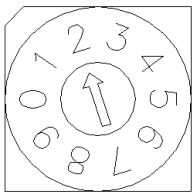

X 10 (MSD)

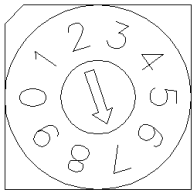

X 1 (LSD)

The above figure shows MAC ID 27(=2*10 + 7*1) of a slave node.

◆ Communication Speed Setting

- See Master Module Setting about communication speed setting.

ATTENTION



MAC ID addresses have to be unique throughout the entire interconnected networks..

6.2.4. Choice of PROFIBUS data transfer cable type

Depending on the application, the user can choose between electrical and optical fiber data transfer cables. The following types of electrical data cables can be used:

- **Standard bus cable**
- **Standard bus cable with halogen-free sheath (type FRNC)**
- **Cable with PE Sheath** for use in the food and manufacturing industries. (it differs from the standard bus cable solely in the cable sheath).
- **Direct buried cable** with additional protective sheath for laying in the ground.
- **Trailing cable** (this is a special cable type which is used where parts of the machine move occasionally or continuously).
- **Festooned cable**. Compared to a trailing cable, a festooned cable has an additional strain relief element.

The bus cable is specified in EN 50170 part 8-2 as " Cable Type A", and should comply with the parameters in the following table. Cable Type B, which is also described in EN 50170, is outdated and should no longer be used.

Table 1. show the parameters for standard type A bus cables.

Parameter	Cable type A
Characteristic impedance in Ω	135..165 at a frequency of (3..20MHz)
Operating capacity(pF/m)	< 30
Loop resistance (Ω /km)	<=110
Core diameter (mm)	>0.64*
Cora cross-section (mm)	>0.34*

* The cable cross-sections used should be compatible with the mechanical specifications of the bus interface connector

The cable parameters specified for standard Type A bus cables result in the maximum length of each bus segment for the respective data transfer rate shown in Table 2.

Table 2 : Maximum cable lengths per segment

Baudrate	9.6	19.2	45.45	93.75	187.5	500	1500	3000	6000	12000
Max. segment Length in 'm'(m)	1200	1200	1200	1200	1000	400	200	100	100	100

Important : In a PROFIBUS-DP/FMS installation, you must choose a data transfer rate which is supported by all devices connected to the bus. The chosen data transfer rate then determines the maximum segment lengths as shown above.

The maximum admissible distance between two bus stations in each PROFIBUS network can be calculated as follows:

(NO_REP+1)*Segment length

NO_REP=The maximum number of repeaters connected in series(depends on repeater type).

Example : The repeater manufacture specifications allow nine repeaters to be connected in series. The maximum distance between two bus stations at a data transfer rate of 1500 kbit/s is then as follow:
 $(9+1)*200m=2000 m$

6.2.5. I/O Process Image Map

An expansion module may have 3 types of data as I/O data, configuration parameter and memory register.

The data exchange between network adapter and expansion modules is done via an I/O process image data by FnBus protocol. The following figure shows the data flow of process image between network adapter and expansion modules.

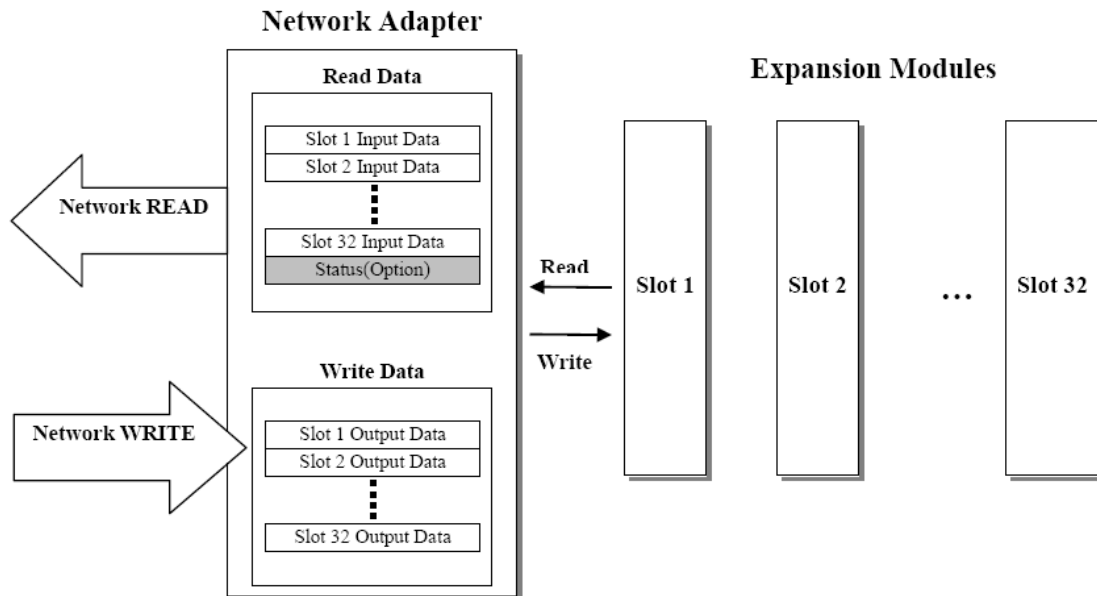

7. Parameter

7.1. GN-9222

Parameter length: 3 bytes

Parameter Data:

Offset	Access	Decimal Bit	Description	Default Value
3	R/W	00-01	Word Data Format 0 : Little-Endian (INTEL) 1 : Big-Endian (MOTOROLA)	1 (Motorola)
		02-07	Reserved	0
4	R/W	00-04	Reserved	0
		05	PROFIBUS Disconnection 0: Fault values are switched 1: Hold last state	1
		06-07	Reserved	0
5	R/W	00-07	IO Scan Rate (Unit : us) ¹⁾	1000 (us)

1) IO Scan Rate is changed by IO data size(In + Output data). refer to below, the fastest IO scan rate for each cases.

example	10byte ▶ about 40us	100byte ▶ about 60us
	500byte ▶ about 160us	1000byte ▶ about 260us

8. DPV1

Service

8.1. MSAC1 Read(PROFIBUS-DP Extensions to EN50170)

■ MSAC1 Read request

Parameter	Description
Remote Address	Slave Address (0~99)
Slot Number	Slot Number : 0(GN-9222)
Index	253 : FW revision (Data size : 4bytes) 254 : Vendor code (Data size : 1 byte)
Length	1~128

■ MSAC1 Read Confirm(+)

Parameter	Description
Remote Address	Slave Address (0~99)
Length	1~128
Data	User Data

■ MSAC1 Read Confirm(-)

Parameter	Description
Remote Address	Slave Address (0~99)
Error Decode	-
Error code 1	-
Error code 2	Reserved

8.2. MSAC1 Write (PROFIBUS-DP Extensions to EN50170)

MSAC1 Write Request

Parameter	Description
Remote Address	Slave Address (0~99)
Slot Number	Slot Number : 0(GN-9222)
Index	254 : Vendor code (Data size : 5 bytes)
Length	1~128
Data	Vendor (Don't mention this to the User manual) - Data[0] : 0xAE - Data[1] : 0xBE - Data[2] : 0xCE - Data[3] : 0xDE - Vendor code

MSAC1 Write Confirm (+)

Parameter	Description
Remote Address	Slave Address (0~99)
Length	1~128

MSAC1 Write Confirm (-)

Parameter	Description
Remote Address	Slave Address (0~99)
Error Decode	-
Error code 1	-
Error code 2	Reserved

Parameter	Description
C_Ref	Communication-Reference
Error Decode	-
Error_code 1	-
Error_code 2	Reserved

8.3. Error_Decode (PROFIBUS-DP Extensions to EN50170)

- ▶ 0~127 : Reserved
- ▶ 128 : DPV1
- ▶ 129~253 : Reserved
- ▶ 254 : FMS
- ▶ 255 : HART

8.4. Error_Code_1 (PROFIBUS-DP Extensions to EN50170)

Bit	7	6	5	4	3	2	1	0
1	Error Class 0xA : Application class				Error code 0 : Read Error 1 : Write Error 2 : Module Failure 3 ~7 : Reserved 8 : Version conflict 9 : Feature not supported 10~15 : User specific			
2	Error Class 0xB : Access class				Error code 0 : Invalid index 1 : Write length error 2 : Invalid slot 3 : Type conflict 4 : Invalid area 5 : state conflict 6 : access denied 7 : invalid range 8 : invalid parameter 9 : invalid type 10~15 : User specific			
3	Error Class 0xC : Resource class				Error code 0 : read constrain conflict 1 : Write constrain conflict 2 : Resource busy 3 : Resource unavailable 4 ~7 : Reserved 8~15 : User specific			
4	Error Class 0xD : GN-9222 Specific Class				Error code 1 : Slot Parameter write error 2 : Read memory error 3 : Write memory error			

8.5. Diagnostics

Byte	Item	Description
0	Station status 1	PROFIBUS Standard Diagnostic
1	Station status 2	
2	Station status 3	
3	Master Address	
4	PNO Ident Number High	
5	PNO Ident Number Low	

• Station Status 1~3

Station status			
1	Bit 7	Master_Lock	Slave is parameterized by another master
	Bit 6	Prm_Fault	Last parameter telegram faulty
	Bit 5	Inv._SI_Res.	Inplausible response of the slave
	Bit 4	Not_Supp.	Unknown command detected by the slave
	Bit 3	Ext_Diag	The area Ext_Diag is used for extended diagnostic
	Bit 2	Cfg_Fault	Slave is wrong parameterized
	Bit 1	Sta._Not_Rdy	Slave not ready
	Bit 0	Sta._Non_Exist.	Slave not responding
2	Bit 7	Deactivated	Slave not projected
	Bit 6	Reserved	Reserved
	Bit 5	Sync_Mode	Sync-command active
	Bit 4	Freeze_Mode	Freeze-command active
	Bit 3	WD_On	Watchdog activated
	Bit 2	1	Always 1
	Bit 1	Stat_Diag	Get diagnostic from slave, till bit is released
	Bit 0	Prm_	Slave must be parameterized
3	Bit 7	Ext_Diag_Ovfl.	The slave has more diagnostic data available than it can send
-	Bit 6~0	Reserved	Reserved

9. MODBUS Interface

9.1. MODBUS Interface Register/Git Map

• Register Map

Start Address	Read/Write	Description	Func. Code
0x0000 ~	Read	Process input image registers (Real Input Register)	3,4,23
0x0800 ~	Read/Write	Process output image registers (Real Output Register)	3,16,23
0x1000 *	Read	Adapter Identification special registers.	3,4,23
0x1020 *	Read/Write	Adapter Watchdog, other time special register.	3,4,6,16,23
0x1100 *	Read/Write	Adapter Information special registers.	3,4,6,16,23
0x2000 *	Read/Write	Expansion Slot Information special registers.	3,4,6,16,23

* The special register map must be accessed by read/write of every each address (one address).

• Register Map

Start Address	Read/Write	Description	Func. Code
0x0000 ~	Read	Process input image bits All input registers area are addressable by bit address. Size of input image bit is size of input image register * 16.	2
0x1000 ~	Read/Write	Process output image bits All output registers area are addressable by bit address. Size of output image bit is size of output image register * 16.	1,5,15

9.2. Supported MODBUS Function Codes

Function Code	Function	Description
1(0x01)	Read Coils (Read output bit)	This function code is used to read from 1 to 2000 contiguous status of coils in a remote device. The Request PDU specifies the starting address, i.e. the address of the first coil specified, and the number of coils. In the PDU Coils are addressed starting at zero. Therefore coils numbered 1-16 are addressed as 0-15. The coils in the response message are packed as one coil per bit of the data field. Status is indicated as 1= ON and 0= OFF.
2(0x02)	Read Discrete Inputs (Read input bit)	This function code is used to read from 1 to 2000 contiguous status of discrete inputs in a remote device. The Request PDU specifies the starting address, i.e. the address of the first input specified, and the number of inputs. In the PDU Discrete Inputs are addressed starting at zero. Therefore Discrete inputs numbered 1-16 are addressed as 0-15. The discrete inputs in the response message are packed as one input per bit of the data field. Status is indicated as 1= ON; 0= OFF.

3(0x03)	Read Holding Registers (Read output word)	This function code is used to read the contents of a contiguous block of holding registers in a remote device. The Request PDU specifies the starting register address and the number of registers. The register data in the response message are packed as two bytes per register, with the binary contents right justified within each byte. For each register, the first byte contains the high order bits and the second contains the low order bits.
4(0x04)	Read Input Registers (Read input word)	This function code is used to read from 1 to approx. 125 contiguous input registers in a remote device. The Request PDU specifies the starting register address and the number of registers. The register data in the response message are packed as two bytes per register, with the binary contents right justified within each byte. For each register, the first byte contains the high order bits and the second contains the low order bits.
5(0x05)	Write Single Coil (Write one bit output)	This function code is used to write a single output to either ON or OFF in a remote device. The requested ON/OFF state is specified by a constant in the request data field. A value of FF 00 hex requests the output to be ON. A value of 00 00 requests it to be OFF. All other values are illegal and will not affect the output.
6(0x06)	Write Single Register (Write one word output)	This function code is used to write a single holding register in a remote device. Therefore register numbered 1 is addressed as 0. The normal response is an echo of the request, returned after the register contents have been written.
8(0x08)	Diagnostics (Read diagnostic register) *Refer to the 6.2.1	MODBUS function code 08 provides a series of tests for checking the communication system between a client (Master) device and a server (Slave), or for checking various internal error conditions within a server. The function uses a two-byte sub-function code field in the query to define the type of test to be performed. The server echoes both the function code and subfunction code in a normal response. Some of the diagnostics cause data to be returned from the remote device in the data field of a normal response.
15(0x0F)	Write Multiple Coils (Write a number of output bits)	This function code is used to force each coil in a sequence of coils to either ON or OFF in a remote device. The Request PDU specifies the coil references to be forced. Coils are addressed starting at zero. A logical '1' in a bit position of the field requests the corresponding output to be ON. A logical '0' requests it to be OFF. The normal response returns the function code, starting address, and quantity of coils forced.
16(0x10)	Write Multiple registers (Write a number of output words)	This function code is used to write a block of contiguous registers (1 to approx. 120 registers) in a remote device. The requested written values are specified in the request data field. Data is packed as two bytes per register. The normal response returns the function code, starting address, and quantity of registers written.
23(0x17)	Read/Write Multiple registers (Read a number of input words /Write a number of output words)	Read a number of input words /Write a number of output words This function code performs a combination of one read operation and one write operation in a single MODBUS transaction. The write operation is performed before the read. The request specifies the starting address and number of holding registers to be read as well as the starting address, number of holding registers, and the data to be written. The byte count specifies the number of bytes to follow in the write data field. The normal response contains the data from the group of registers that were read. The byte count field specifies the quantity of bytes to follow in the read data field.

- Refer to MODBUS APPLICATION PROTOCOL SPECIFICATION V1.1a

9.2.1. 8(0x08) Diagnostics

Sub-function 0x0000(0) Return Query Data

The data passed in the request data field is to be returned (looped back) in the response. The entire response message should be identical to the request.

Sub-function	Data Field (Request)	Data Field (Response)	Description
0x0000(0)	Any	Echo Request Data	

Sub-function 0x0001(1) Restart Communications Option

The remote device could be initialized and restarted, and all of its communications event counters are cleared. Especially, data field 0x55AA make the remote device to restart with factory default setup of EEPROM.

Sub-function	Data Field (Request)	Data Field (Response)	Description
0x0001(1)	0x0000, 0xFF00	Echo Request Data	Reset Only

Sub-function 0x000A(10) Clear Counters and Diagnostic Register

The goal is to clear all counters and the diagnostic register. Counters are also cleared upon power-up.

Sub-function	Data Field (Request)	Data Field (Response)	Description
0x000A(10)	0x0000	Echo Request Data	

Sub-function 0x000B(11) Return Bus Message Count

The response data field returns the quantity of messages that the remote device has detected on the communications system since its last restart, clear counters operation, or power-up.

Sub-function	Data Field (Request)	Data Field (Response)	Description
0x000B(11)	0x0000	Total Message Count	

Sub-function 0x000D(13) Return Bus Exception Error Count

The response data field returns the quantity of MODBUS exception responses returned by the remote device since its last restart, clear counters operation, or power-up.

Exception responses are described and listed in section 3.2.11.

Sub-function	Data Field (Request)	Data Field (Response)	Description
0x000D(13)	0x0000	Exception Error Count	

Sub-function 0x000E(14) Return Slave Message Count

The response data field returns the quantity of messages addressed to the remote device, or broadcast, that the remote device has processed since its last restart, clear counters operation, or power-up.

Sub-function	Data Field (Request)	Data Field (Response)	Description
0x000E(14)	0x0000	Slave Message Count	

Sub-function 0x000F(15) Return Slave No Response Count

The response data field returns the quantity of messages addressed to the remote device for which it has returned no response (neither a normal response nor an exception response), since its last restart, clear counters operation, or power-up.

Sub-function	Data Field (Request)	Data Field (Response)	Description
0x000F(15)	0x0000	Slave No Response Count	

Sub-function 0x0064(100) Return Slave ModBus, Expansion Module Status

The response data field returns the status of ModBus and expansion module addressed to the remote device. This status values are identical with status 1 word of input process image. Refer to 2.4.2.

Sub-function	Data Field (Request)	Data Field (Response)	Description
0x0064(100)	0x0000	ModBus, RBUS Status	Same as status 1 word

8.2.2. Error Response

In an exception response, the server sets the MSB of the function code to 1. This makes the function code value in an exception response exactly 80 hexadecimal higher than the value would be for a normal response.

- **Exception Codes**

Exception Code	Name	Description
01	Illegal Function	The function code received in the query is not an allowable action for the server (or slave).
02	Illegal Data Address	The data address received in the query is not an allowable address for the server (or slave).
03	Illegal Data Value	A value contained in the query data field is not an allowable value for server (or slave).
04	Slave Device Failure	An unrecoverable error occurred while the server (or slave) was attempting to perform the requested action.
05	Acknowledge	The server (or slave) has accepted the request and is processing it, but a long duration of time will be required to do so.
06	Slave Device Busy	Specialized use in conjunction with programming commands. The server (or slave) is engaged in processing a long-duration program command. The client (or master) should retransmit the message later when the server (or slave) is free.
08	Memory Parity Error	The server (or slave) attempted to read record file, but detected a parity error in the memory. The client (or master) can retry the request, but service may be required on the server (or slave) device.
0A	Gateway Path Unavailable	Specialized use in conjunction with gateways, indicates that the gateway was unable to allocate an internal communication path from the input port to the output port for processing the request.

9.3. MODBUS Special Register Map

The special register map can be accessed by function code 3, 4, 6 and 16. Also the special register map must be accessed by read/write of every each address (one address).

9.3.1. Adapter Identification Special Resgister (0x1000, 4096)

Address	Access	Type, Size	Description
0x1000(4096)	Read	1word	Vendor ID = 0x029D(669), Crevis. Co., Ltd.
0x1001(4097)	Read	1word	Device type = 0x000C, Network Adapter
0x1002(4098)	Read	1word	Product Code = 0x9040
0x1003(4099)	Read	1word	Firmware revision, if 0x0100, revision 1.00
0x1004(4100)	Read	2word	Product unique serial number
0x1005(4101)	Read	String up to 34byte	Product name string (ASCII) "GN-9222_Profibus,G-Series"
0x1006(4102)	Read	1word	Sum check of EEPROM
0x1010(4112)	Read	2word	Firmware release date
0x101E(4126)	Read	7word - 1word - 1word - 1word - 1word - 1word - 2word	Composite Id of following address 0x1100(4352), Modbus Node. (Fixed 0x0001) 0x1000(4096), Vendor ID 0x1001(4097), Device type 0x1002(4098), Product code 0x1003(4099), Firmware revision 0x1004(4100), Product serial number

- String Type consists of valid string length (first 1word) and array of characters

9.3.2. Adapter Information Special Register (0x1100, 4352)

Address	Access	Type, Size	Description
0x1102(4354)	Read	1word	Start address of input image word register. =0x0000
0x1103(4355)	Read	1word	Start address of output image word register. =0x0800
0x1104(4356)	Read	1word	Size of input image word register.
0x1105(4357)	Read	1word	Size of output image word register.
0x1106(4358)	Read	1word	Start address of input image bit. = 0x0000
0x1107(4359)	Read	1word	Start address of output image bit. =0x1000
0x1108(4360)	Read	1word	Size of input image bit.
0x1109(4361)	Read	1word	Size of output image bit.
0x110D(4365)	Read	1word	Field Power & Node ID Dip Switch State. ex) Field Power ON, Dip SW On = 10000000 11111111
0x110E(4366)	Read	upto 33word	Expansion slot's GT-number including GN First 1word is adapter's number, if GN-9289, then 0x9289
0x1110(4368)	Read	1word	Number of expansion slot
0x1113(4371)	Read	upto 33word	Expansion slot Module Id. Refer to Appendix A.1 Product List. First 1word is adapter's module id.
0x1119(4377)	Read	1word	Hi byte is ModBus status, low byte is internal status. Zero value means 'no error'.
0x111D(4381)	Read	1word	Adapter G-Series Revision. If 0x013C, G-Series Revision is 1.60

* ** After the system is reset, the new "Set Value" action is applied.

** If the slot location is changed, set default value automatically (all expansion slot are live).

9.3.3. Expansion Slot Information Special Resister (0x2000, 8192)

Each expansion slot has 0x20(32) address offset and same information structure.

Slot#1 0x2000(8192)~0x201F(8223) Slot#2 0x2020(8224)~0x203F(8255)
 Slot#3 0x2040(8256)~0x205F(8287) Slot#4 0x2060(8288)~0x207F(8319)
 Slot#5 0x2080(8320)~0x209F(8351) Slot#6 0x20A0(8352)~0x20BF(8383)
 Slot#7 0x20C0(8384)~0x20DF(8415) Slot#8 0x20E0(8416)~0x20FF(8447)
 Slot#9 0x2100(8448)~0x211F(8479) Slot#10 0x2120(8480)~0x213F(8511)
 Slot#11 0x2140(8512)~0x215F(8543) Slot#12 0x2160(8544)~0x217F(8575)
 Slot#13 0x2180(8576)~0x219F(8607) Slot#14 0x21A0(8608)~0x21BF(8639)
 Slot#15 0x21C0(8640)~0x21DF(8671) Slot#16 0x21E0(8672)~0x21FF(8703)
 Slot#17 0x2200(8704)~0x221F(8735) Slot#18 0x2220(8736)~0x223F(8767)
 Slot#19 0x2240(8768)~0x225F(8799) Slot#20 0x2260(8800)~0x227F(8831)
 Slot#21 0x2280(8832)~0x229F(8863) Slot#22 0x22A0(8864)~0x22BF(8895)
 Slot#23 0x22C0(8896)~0x22DF(8927) Slot#24 0x22E0(8928)~0x22FF(8959)
 Slot#25 0x2300(8960)~0x231F(8991) Slot#26 0x2320(8992)~0x233F(9023)
 Slot#27 0x2340(9024)~0x235F(9055) Slot#28 0x2360(9056)~0x237F(9222)
 Slot#29 0x2380(9088)~0x239F(9119) Slot#30 0x23A0(9120)~0x23BF(9151)
 Slot#31 0x23C0(9152)~0x23DF(9183) Slot#32 0x23E0(9184)~0x23FF(9215)
 Slot#33 0x2400(9216)~0x241F(9247) Slot#34 0x2420(9248)~0x243F(9279)

 Slot#63 0x27C0(10176)~0x27DF(10207)

Address Offset	Expansion Slot#1	Expansion Slot#2	Expansion Slot#3	Expansion Slot#4	Expansion Slot#63
+ 0x00(+0)	0x2000(8192)	0x2020(8224)	0x2040(8256)	0x2060(8288)	0x27C0(10176)
+ 0x01(+1)	0x2001(8193)	0x2021(8225)	0x2041(8257)	0x2061(8289)		0x27C1(10177)
+ 0x02(+2)	0x2002(8194)	0x2022(8226)	0x2042(8258)	0x2062(8290)		0x27C2(10178)
+ 0x03(+3)	0x2003(8195)	0x2023(8227)	0x2043(8259)	0x2063(8291)		0x27C3(10179)
+ 0x04(+4)	0x2004(8196)	0x2024(8228)	0x2044(8260)	0x2064(8292)		0x27C4(10180)
+ 0x05(+5)	0x2005(8197)	0x2025(8229)	0x2045(8261)	0x2065(8293)		0x27C5(10181)
+ 0x06(+6)	0x2006(8198)	0x2026(8230)	0x2046(8262)	0x2066(8294)		0x27C6(10182)
+ 0x07(+7)	0x2007(8199)	0x2027(8231)	0x2047(8263)	0x2067(8295)		0x27C7(10183)
+ 0x08(+8)	0x2008(8200)	0x2028(8232)	0x2048(8264)	0x2068(8296)		0x27C8(10184)
+ 0x09(+9)	0x2009(8201)	0x2029(8233)	0x2049(8265)	0x2069(8297)		0x27C9(10185)
+ 0x0A(+10)	0x200A(8202)	0x202A(8234)	0x204A(8266)	0x206A(8298)		0x27CA(10186)
+ 0x0B(+11)	0x200B(8203)	0x202B(8235)	0x204B(8267)	0x206B(8299)		0x27CB(10187)
+ 0x0C(+12)	0x200C(8204)	0x202C(8236)	0x204C(8268)	0x206C(8300)		0x27CC(10188)
+ 0x0D(+13)	0x200D(8205)	0x202D(8237)	0x204D(8269)	0x206D(8301)		0x27CD(10189)
+ 0x0E(+14)	0x200E(8206)	0x202E(8238)	0x204E(8270)	0x206E(8302)		0x27CE(10190)
+ 0x0F(+15)	0x200F(8207)	0x202F(8239)	0x204F(8271)	0x206F(8303)		0x27CF(10191)
+ 0x10(+16)	0x2010(8208)	0x2030(8240)	0x2050(8272)	0x2070(8304)		0x27D0(10192)
+ 0x11(+17)	0x2011(8209)	0x2031(8241)	0x2051(8273)	0x2071(8305)		0x27D1(10193)
+ 0x12(+18)	0x2012(8210)	0x2032(8242)	0x2052(8274)	0x2072(8306)		0x27D2(10194)
+ 0x13(+19)	0x2013(8211)	0x2033(8243)	0x2053(8275)	0x2073(8307)		0x27D3(10195)
+ 0x14(+20)	0x2014(8212)	0x2034(8244)	0x2054(8276)	0x2074(8308)		0x27D4(10196)
+ 0x15(+21)	0x2015(8213)	0x2035(8245)	0x2055(8277)	0x2075(8309)		0x27D5(10197)
+ 0x16(+22)	0x2016(8214)	0x2036(8246)	0x2056(8278)	0x2076(8310)		0x27D6(10198)
+ 0x17(+23)	0x2017(8215)	0x2037(8247)	0x2057(8279)	0x2077(8311)		0x27D7(10199)
+ 0x18(+24)	0x2018(8216)	0x2038(8248)	0x2058(8280)	0x2078(8312)		0x27D8(10200)
+ 0x19(+25)	0x2019(8217)	0x2039(8249)	0x2059(8281)	0x2079(8313)		0x27D9(10201)
+ 0x1A(+26)	0x201A(8218)	0x203A(8250)	0x205A(8282)	0x207A(8314)		0x27DA(10202)
+ 0x1B(+27)	0x201B(8219)	0x203B(8251)	0x205B(8283)	0x207B(8315)		0x27DB(10203)
+ 0x1C(+28)	0x201C(8220)	0x203C(8252)	0x205C(8284)	0x207C(8316)		0x27D8C(10204)
+ 0x1D(+29)	0x201D(8221)	0x203D(8253)	0x205D(8285)	0x207D(8317)		0x27DD(10205)
+ 0x1E(+30)	0x201E(8222)	0x203E(8254)	0x205E(8286)	0x207E(8318)		0x27DE(10206)
+ 0x1F(+31)	0x201F(8223)	0x203F(8255)	0x205F(8287)	0x207F(8319)		0x27DF(10207)

Address Offset	Access	Type, Size	Description
+ 0x02(+2) **	Read	1word	Input start register address of input image word this slot.
+ 0x03(+3) **	Read	1word	Input word's bit offset of input image word this slot.
+ 0x04(+4) **	Read	1word	Output start register address of output image word this slot.
+ 0x05(+5) **	Read	1word	Output word's bit offset of output image word this slot.
+ 0x06(+6) **	Read	1word	Input bit start address of input image bit this slot.
+ 0x07(+7) **	Read	1word	Output bit start address of output image bit this slot.

+ 0x08(+8) **	Read	1word	Size of input bit this slot
+ 0x09(+9) **	Read	1word	Size of output bit this slot
+ 0x0A(+10) **	Read	n word	Read input data this slot
+ 0x0B(+11) **	Read/Write	n word	Read/write output data this slot
+ 0x0E(+14)	Read	1word	RT-number, if RT-1238, returns 0x1238
+ 0x0F(+15)	Read	String up to 74byte	First 1word is length of valid character string. If RT-1238, returns "00 1E 52 54 2D 31 32 33 38 2C 20 38 44 49 2C 20 32 34 56 64 63 2C 20 55 6E 69 76 65 72 73 61 6C 00 00" Valid character size = 0x001E =30 characters, "RT-1238, 8DI, 24Vdc, Universal"
+ 0x10(+16)	Read	1word	Size of configuration parameter byte
+ 0x11(+17) **	Read/Write	n word	Read/write Configuration parameter data, up to 8byte. Refer to A.2 ***
+ 0x17(+23) **	Read/Write	2word	Firmware Revision
+ 0x19(+25) **	Read/Write	2word	Firmware release date.

** After the system is reset, the new "Set Value" action is applied.

*** Nothing of output, input, memory or configuration parameter corresponding slot returns Exception 02.

10. Trouble Shooting

10.1. How to diagnose by LED indicator

LED Status	Cause	Action
All LED turns off	- No power	- Check main power Cable
MOD LED is red	- Occurrence critical error in firmware	- Contact Sales team and send module for repair.
NET LED turns off	Failure of communication with Master	Check main power for master and communication cable.
NET LED flashed green	Failure of exchanging data with master	Check status in software for Master configuration.
NET LED is red	Failed communication	- Contact Sales team and send module for repair.
DIA Flashing Red with MOD led is red	Device has hardware checking error.	- Contact Sales team and send module for repair.
DIA Flashing Red with IOS led is red	Device has expansion module error.	- Contact Sales team and send module for repair.
DIA Flashing Red	Failed to initialize expansion module - Overflow Input/Output size. (244bytes / 244bytes) - Overflow Configuration data size. (244bytes / 244bytes) - Too many expansion module. (Max 63 slot) - Mismatch vendor code between adapter and expansion module.	- Use expansion slot up to 63. - Compose that IO total size is not excess. - Check status of expansion IO connection. - Check the vendor code of module.
IOS LED turns off	- Device may not be powered.	- Check main power Cable
IOS LED flashes red	- Adapter has no expansion module	- Add one or more expansion modules.
IOS LED is red	One or more expansion module occurred in fault state. - Detected invalid expansion module ID. - Overflowed Input/Output Size - Too many expansion module - Initialization failure - Communication failure. - Changed expansion module configuration. - Mismatch vendor code between adapter and expansion module.	- Use expansion slot up to 63. - Compose that IO total size is not excess. - Check status of expansion IO connection. - Check the vendor code of module.
Field Power LED turns off	- Field power is not supplied.	- Check main power Cable - Contact Sales team and send module for repair.

System Power LED turns off	- System power is not supplied.	- Check main power Cable - Contact Sales team and send module for repair.
----------------------------	---------------------------------	------------------------------------------------------------------------------

How to diagnose when device couldn't communicate network

Inspection of wrong or omission cable connection.

- Check status of cable connection for each node.
- Check that all color matches between connector and cable.
- Check wire omission.

Terminator resistor

- If terminator resistor is not installed, install terminator resistor
- Check location of terminator resistor

Configuration of Node address

- Check duplication node address.

Configuration of Master

- Check configuration of master
- Check whether to do download or don't
- Check composition is right
 - Configuration of communication baud rate
 - I/O size
 - Configuration of each nodes

Ground and environment

- Check ground is contacted
- Check environment factor(temperature, humidity, etc) is in less than regular limit

APPENDIX A

A.1 Product List

No.	GT-Number	Description	ID(hex)
Digital Input Module			
1	GT-1238	8 Points, Universal, 24Vdc, 10RTB	1238
2	GT-123F	16 Points, Universal, 24Vdc, 20P connector	123F
3	GT-12DF	16 Points, Universal, 24Vdc, 18RTB	12DF
4	GT-12FA	32 Points, Universal, 24Vdc, 40P connector	12FA
5	GT-1804	4 Points, 120Vac, 10RTB	1804
6	GT-1904	4 Points, 240Vac, 10RTB	1904
Digital Output Module			
7	GT-2318	8 Points, Sink, 24Vdc/0.5A, 10RTB	2318
8	GT-2328	8 Points, Source, 24Vdc/0.5A, 10RTB	2328
9	GT-221F	16 Points, Sink, 24Vdc/0.3A, 20P connector	221F
10	GT-222F	16 Points, Source, 24Vdc/0.3A, 20P connector	222F
11	GT-225F	16 Points, Sink, 24Vdc/0.3A, 18RTB	225F
12	GT-226F	16 Points, Source, 24Vdc/0.3A, 18RTB	226F
13	GT-22BA	32 Points, Sink, 24Vdc/0.3A, 40P connector	22BA
14	GT-22CA	32 Points, Source, 24Vdc/0.3A, 40P connector	22CA
15	GT-2618	8 Points, Sink, 24Vdc/2A, 10RTB	2618
16	GT-2628	8 Points, Source, 24Vdc/2A, 10RTB	2628
17	GT-2734	4 Points, MOS Relay, 240Vdc/ac, 0.5A, 10RTB	2734
18	GT-2744	4 Points, Relay, 24Vdc/2A, 240Vac/2A, 10RTB	2744
19	GT-2764	4 Points, MOS Relay, 24Vdc/ac, 2A, 10RTB	2764
20	GT-2784	4 Points, MOS Relay, 110Vdc/ac, 1A, 10RTB	2784
Analog Input Module			
21	GT-3001	LoadCell (TBD)	3001
22	GT-3114	4 Channels, 0~20, 4~20mA, 12bits, 10RTB	3114
23	GT-3154	4 Channels, 0~20, 4~20mA, 16bits, 10RTB	3154
24	GT-3118	8 Channels, 0~20, 4~20mA, 12bits, 10RTB	3118
25	GT-3158	8 Channels, 0~20, 4~20mA, 16bits, 10RTB	3158
26	GT-311F	16 Channels, 0~20, 4~20mA, 12bits, 20P connector	311F
27	GT-315F	16 Channels, 0~20, 4~20mA, 16bits, 20P connector	315F
28	GT-317F	16 Channels, 0~20, 4~20mA, 12bits, 18RTB	317F
29	GT-319F	16 Channels, 0~20, 4~20mA, 16bits, 18RTB	319F
30	GT-3424	4 Channels, 0~10, 0~5, 1~5Vdc, 12bits, 10RTB	3424
31	GT-3464	4 Channels, 0~10, 0~5, 1~5Vdc, 16bits, 10RTB	3464
32	GT-3428	8 Channels, 0~10, 0~5, 1~5Vdc, 12bits, 10RTB	3428
33	GT-3468	8 Channels, 0~10, 0~5, 1~5Vdc, 16bits, 10RTB	3468
34	GT-342F	16 Channels, 0~10, 0~5, 1~5Vdc, 12bits, 20P connector	342F
35	GT-346F	16 Channels, 0~10, 0~5, 1~5Vdc, 16bits, 20P connector	346F
36	GT-347F	16 Channels, 0~10, 0~5, 1~5Vdc, 12bits, 18RTB	347F
37	GT-349F	16 Channels, 0~10, 0~5, 1~5Vdc, 16bits, 18RTB	349F

38	GT-3704	4 Channels, RTD, 10RTB	3704
39	GT-3708	8 Channels, RTD, 20P connector	3708
40	GT-3804	4 Channels, Thermocouple, 10RTB	3804
41	GT-3808	8 Channels, Thermocouple, 20P connector	3808
42	GT-3901	AC Measurement	3901
43	GT-3914	4 Channels, Differential, 0~20, 4~20, +/-20mA, 12Bits, 10RTB	3914
44	GT-3934	4 Channels, Differential, 0~20, 4~20, +/-20mA, 16Bits, 10RTB	3934
45	GT-3918	8 Channels, Differential, 0~20, 4~20, +/-20mA, 12Bits, 18RTB	3918
46	GT-3938	8 Channels, Differential, 0~20, 4~20, +/-20mA, 16Bits, 18RTB	3938
47	GT-3924	4 Channels, Differential, 0~5, 0~10, +/-5, +/-10Vdc, 12Bits, 10RTB	3924
48	GT-3944	4 Channels, Differential, 0~5, 0~10, +/-5, +/-10Vdc, 16Bits, 10RTB	3944
49	GT-3928	8 Channels, Differential, 0~5, 0~10, +/-5, +/-10Vdc, 12Bits, 18RTB	3928
50	GT-3948	8 Channels, Differential, 0~5, 0~10, +/-5, +/-10Vdc, 16Bits, 18RTB	3948
Analog Output Module			
51	GT-4114	4CH, 0~20mA, 12Bits, 10RTB	4114
52	GT-4154	4CH, 0~20mA, 16Bits, 10RTB	4154
53	GT-4118	8CH, 0~20mA, 12Bits, 10RTB	4118
54	GT-4158	8CH, 0~20mA, 16Bits, 10RTB	4158
55	GT-4424	4CH, 0~10Vdc, 12Bits, 10RTB	4424
56	GT-4464	4CH, 0~10Vdc, 16Bits, 10RTB	4464
57	GT-4428	8CH, 0~10Vdc, 12Bits, 10RTB	4428
58	GT-4468	8CH, 0~10Vdc, 16Bits, 10RTB	4468
59	GT-417F	16CH, 0~20mA, 12Bits, 18RTB	417F
60	GT-419F	16CH, 0~20mA, 16Bits, 18RTB	419F
61	GT-442F	16CH, 0~10Vdc, 12Bits, 20P Connector	442F
62	GT-446F	6CH, 0~10Vdc, 16Bits, 20P Connector	446F
63	GT-447F	16CH, 0~10Vdc, 12Bits, 18RTB	447F
64	GT-449F	16CH, 0~10Vdc, 16Bits, 18RTB	449F
Special Module			
65	GT-5102	2CH, Encoder, Input, 5Vdc, 10RTB	5102
66	GT-5211	1CH, RS 232, RTS/CTS, Full Duplex Type, 10RTB	5211
67	GT-5212	2CH, RS 232, Full Duplex Type, 10RTB	5212
68	GT-5221	1CH, RS 485, Full Duplex Type, 10RTB	5221
69	GT-5231	1CH, RS 485, Half Full Duplex Type, 10RTB	5231
70	GT-5232	2CH, RS 485, Half Full Duplex Type, 10RTB	5232
71	GT-5352	2CH, Synchronous Serial Interface Input, 10RTB	5352
72	GT-5521	1CH, Stepper Module (TBD)	5521
Power Module			
73	GT-7408	Shield Module	7408
74	GT-7508	Common for 0Vdc	7508
75	GT-7511	Power Expansion, In 24Vdc, Out 1A/5Vdc	7511
76	GT-7518	Common for 24Vdc	7518
77	GT-7588	Common for 0Vdc, 24Vdc	7588

78	GT-7641	Field Power, 5/24/48 Vdc, 110/220 Vac	7641
----	---------	---------------------------------------	------

A.2. Glossary

- System Power : The power for starting up CPU.
- Field Power : The power for input and output line.
 - Terminator Resistor : Resistor for prevention reflected wave.
- EDS : Electronic Data Sheet.
- Sink : The method of in/output power supply if a device has no power source.
- Source : The method of in/output power supply if a device has the power source.